

Data Sheet



Article number: 021816025333

Description: Clamp with bracket and rubber
SPGU 6025. 333/30 SK

Measures

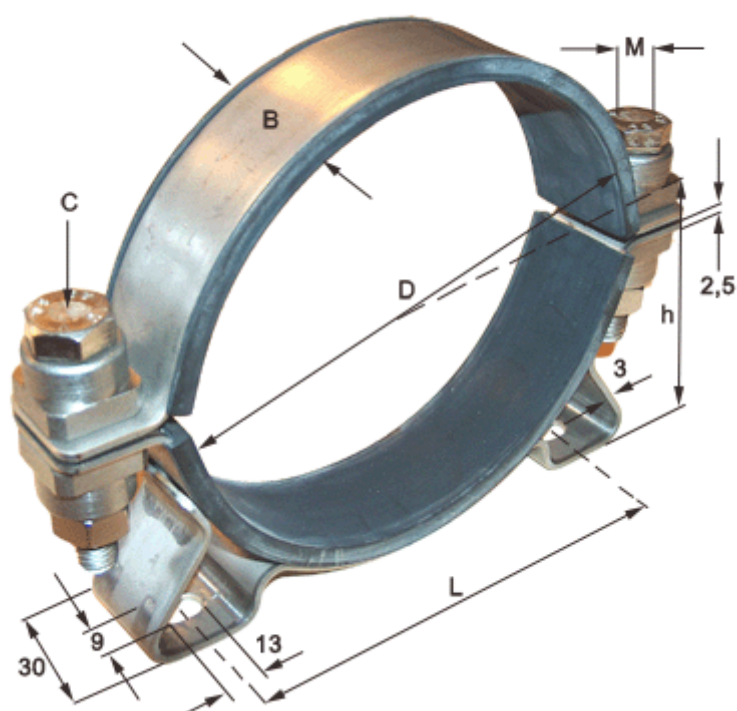

C (screw type) = SK hexagon screw

Diameter D = 333

h = 175

L = 345

Width B = 30